

Xcomfort CTAА-01/02

Montageanweisung
 Assembly instructions
 Instructions de montage
 Montážní návod
 Montagevejledning
 Instrucciones de montaje
 Szerelési utasítás
 Istruzioni di montaggio
 Montasje anvisning
 Montage instructie
 Instruções de montagem
 Instrukcja montażu
 Montageanvisning
 Asennusohjeet
 Montaj talimatı
 Instructiuni de montaj

Инструкция по монтажу
 οδηγία συναρμολόγησης
 装配说明
 تعليمات التركيب





Lebensgefahr
 Danger
 Danger de mort
 Nebezpečí
 Fare
 Peligro
 Életveszély
 Pericolo di morte
 Fare
 Levensgevaar
 Perigo
 Niebezpieczeństwo
 Varning
 Vaara
 Hayati Tehlike
 Pericol
 Опасность
 κίνδυνος θανάτου
 危險
 خطر على الحياة

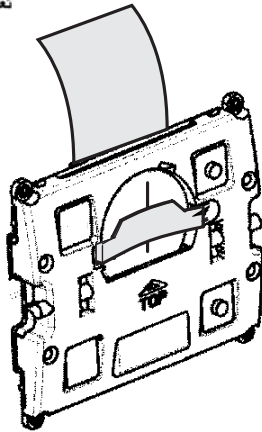

Montage nur durch Elektrofachkräfte
 Installation by electricians only
 Montage uniquement par un électricien
 Montáž pouze osobami s elektrotechnickou kvalifikací
 Må kun installeres af en aut. el-installatør
 Debe ser instalado por un profesional eléctrico
 Csak szakképzett személy szerelheti
 Montaggio esclusivamente ad opera di personale specializzato
 Må monteres av autorisert installatør Gr.L
 Montage alleen door elektromonteurs
 Deve ser instalado por um profissional
 Montaz tylko przez uprawnionych instalatorów
 Får endast utföras av behörig elektriker
 Asennus vain sähköasentajan toimesta
 Sadece uzman kişiler monte edebilir
 Instalare numai de catre electricieni
 Монтаж может производить только элекрик
 οδηγία συναρμολόγησης
 仅允许电工安装
 التركيب فقط من قبل عمال كهرباء اختصاصيين



	T=-25°C - +70°C
	T=+5°C - +40°C

IP20

868,3 MHz

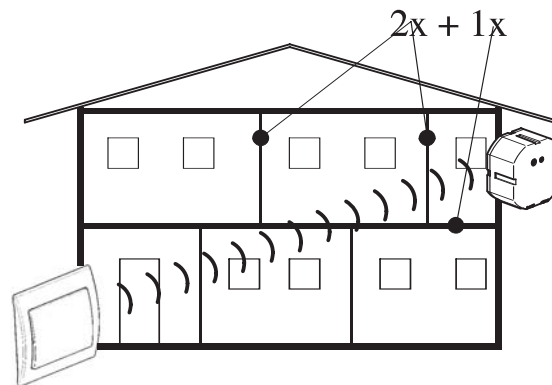
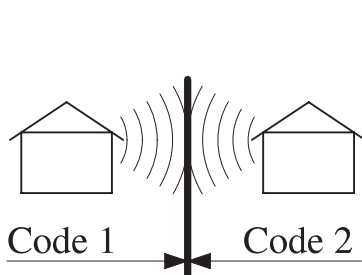
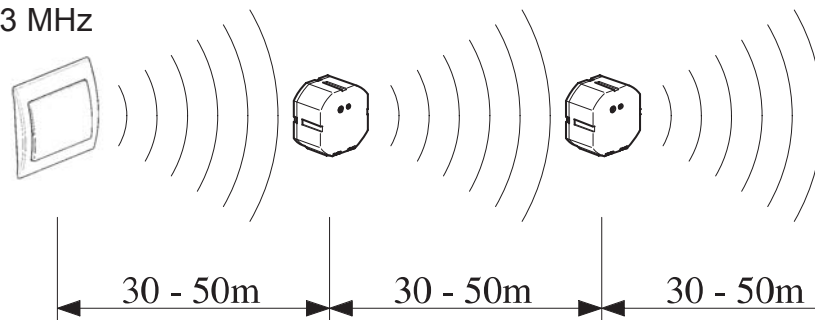

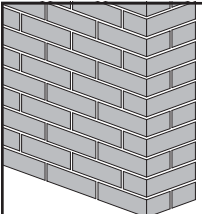
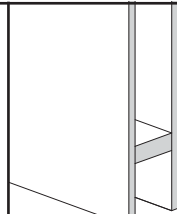
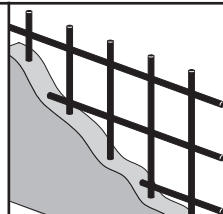
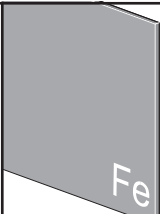
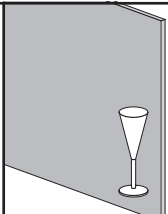
					
	ca. 60-90%	ca. 80-95%	ca. 20-60%	ca. 0-10%	ca. 70-90%

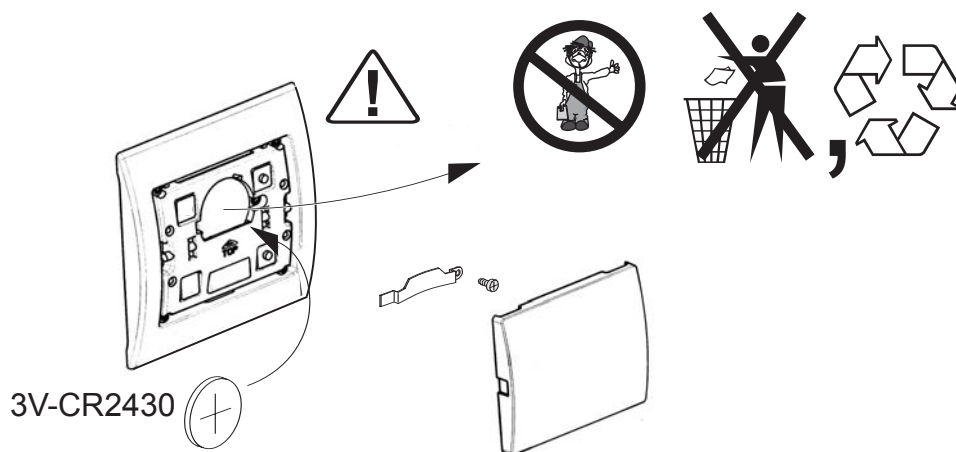
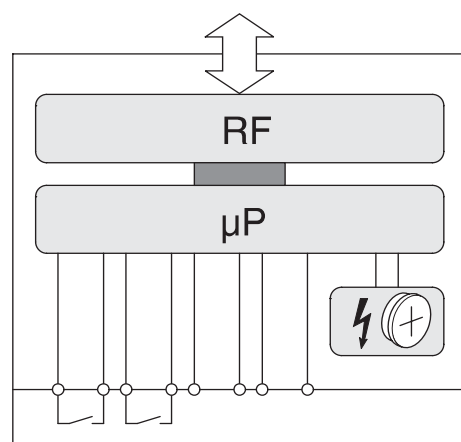
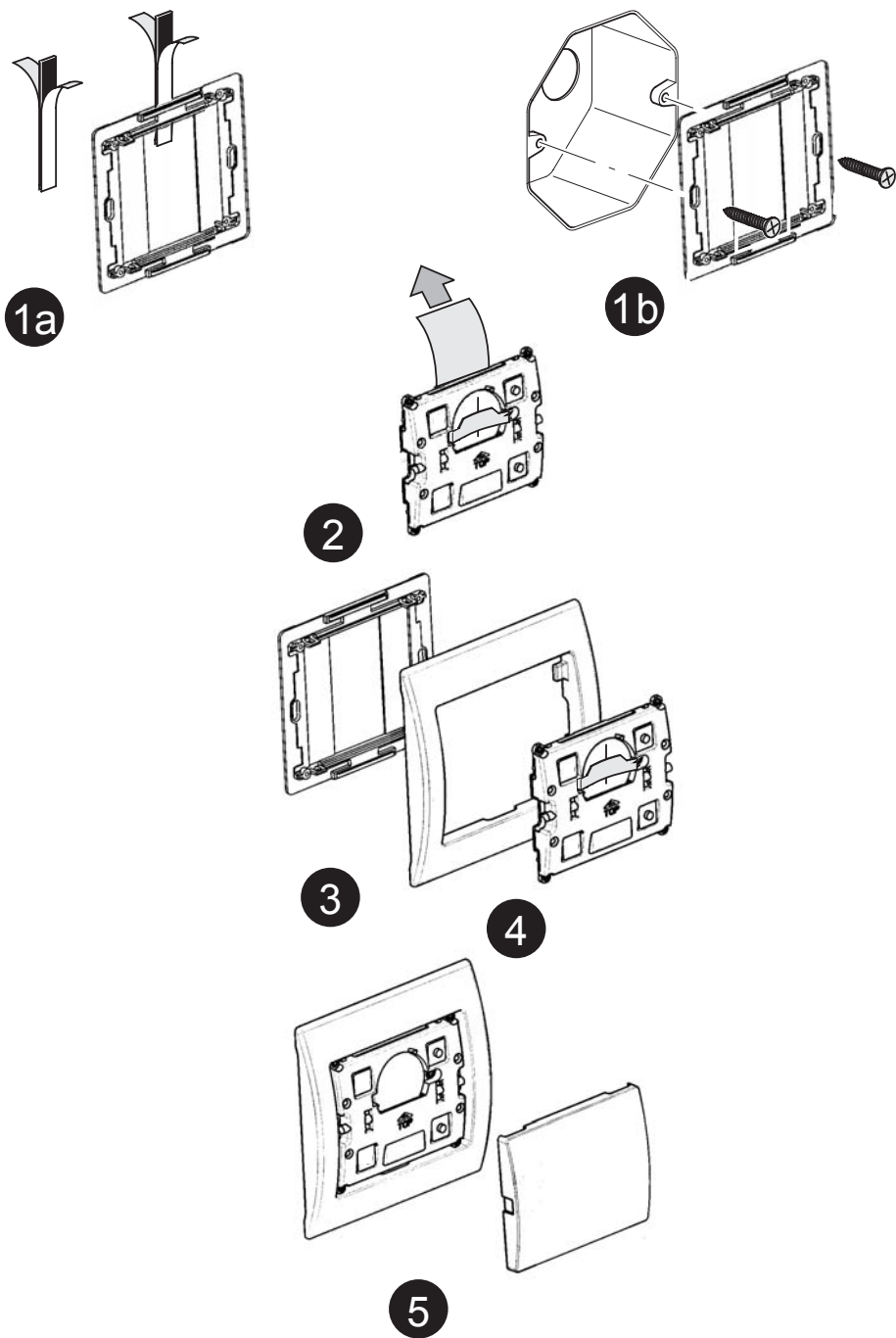

Konformitätsbescheinigung Certification of Conformity

Wir Moeller Gebäudeautomation KG

We (Name des Anbieters / supplier's name)
Eugenia 1
A-3943 Schrems
(Anschrift / address)

bescheinigen hiermit, daß das Produkt
hereby certify that the product

Moeller - Taster
Moeller - Push Button

Type: CTAA-...

type-key according actual catalog

(Bezeichnung, Type oder Modell, Los-, Chargen- oder Serien-Nr., möglichst Herkunft und Stückzahl /
name, type or model, batch or serial number, possible sources and number of items)

auf das sich diese Bescheinigung bezieht, mit der/den folgenden
Norm(en) oder normativen Dokument(en) übereinstimmt.

to which this certification relates is in conformity with the following standard(s)
or other normative document(s).

EN301489-3 V1.4.1, EN50090-2-2/96, EN61000-6-1/01, EN300220-3
V1.1.1, EN60950/00

(Titel und/oder Nr. sowie Ausgabedatum der Norm(en) oder der anderen normativen Dokumente /
Title and/or number and date of issue of the standard(s) or other normative document(s).)

Gemäß den Bestimmungen der Richtlinie(n)

Following the provisions of the Directive(s)

falls zutreffend / if applicable

Niederspannungsrichtlinie 73 / 23 / EWG

Low Voltage Directive 73 / 23 / EWG

EMV-Richtlinie 89 / 336 / EWG

EMC Directive 89 / 336 / EWG

Radio- und Telekommunikationsendgeräte 99 / 05 / EWG

Radio Equipment and Telecommunications Terminal Equipment 99 / 05 / EW

geprüft von / tested by TÜV Österreich, Notified Body 0408
A-1230 Wien, Deutschstrasse 10
CTI-Vienna
A-1210 Wien, Einzingerasse 4

CE 0408

Eine rechtsverbindliche Konformitätserklärung gemäß EN 45014 liegt vor.
The legally declaration of conformity according EN 45014 is available.



Schrems, 09.12.2004

(Ort, Datum der Ausstellung / place, date of issue)

G. Idinger

(Name und Unterschrift / name and signature)

(Ing. F. Schröder)

