



EU
Xcomfort CAEE-02/01

MOELLER

Montageanweisung
Assembly instructions
Instructions de montage
Montážní návod
Montagevejledning
Instrucciones de montaje
Szerelési utasítás
Istruzioni di montaggio
Montasje anvisning
Montage instructie
Instruções de montagem
Instrukcja montażu
Montageanvisning
Asennusohjeet
Montaj talimatı
Instrucțiuni de montaj

Инструкция по монтажу
οδηγία συναρμολόγησης
装配说明
تعليمات التركيب



Lebensgefahr
Danger
Danger de mort
Nebezpečí
Fare
Peligro
Életveszély
Pericolo di morte
Fare
Levensgevaar
Perigo
Niebezpieczeństwo
Varning
Vaara
Hayati Tehlike
Pericol
Опасность
κίνδυνος θανάτου
危險
خطر على الحياة



Montage nur durch Elektrofachkräfte
Installation by electricians only
Montage uniquement par un électricien
Montáž pouze osobami s elektrotechnickou kvalifikací
Må kun installeres af en aut. el-installatør
Debe ser instalado por un profesional eléctrico
Csak szakképzett személy szerelheti
Montaggio esclusivamente ad opera di personale specializzato
Må monteres av autorisert installatør Gr.L
Montage alleen door elektromonteurs
Deve ser instalado por um profissional
Montaz tylko przez uprawnionych instalatorów
Får endast utföras av behörig elektriker
Asennus vain sähköasentajan toimesta
Sadece uzman kişiler monte edebilir
Instalare numai de către electricieni
Монтаж может производить только электрик
Εγκατάσταση μόνο από ηλεκτρολόγους
仅允许电工安装
التركيب فقط من قبل عمال كهرباء اختصاصيين

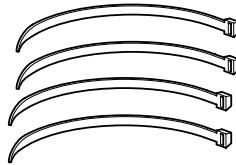
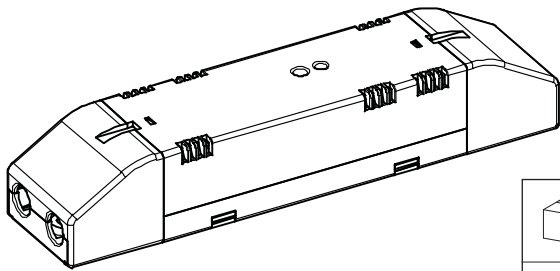

		Min. Version 1.40
		Min. Version 3.6B

	T=-25°C - +70°C
	T=-5°C - +45°C

IP20

868,3 MHz

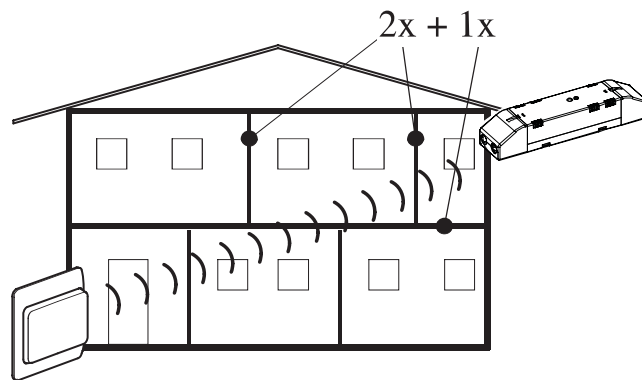
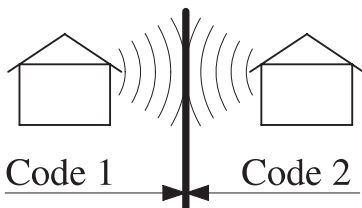
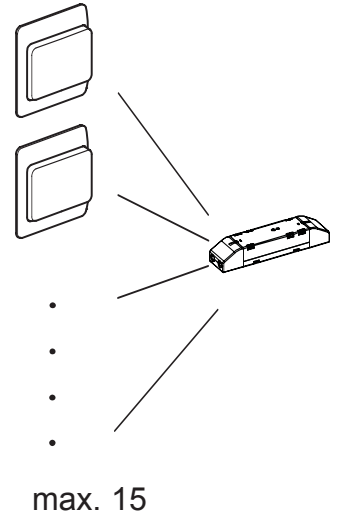
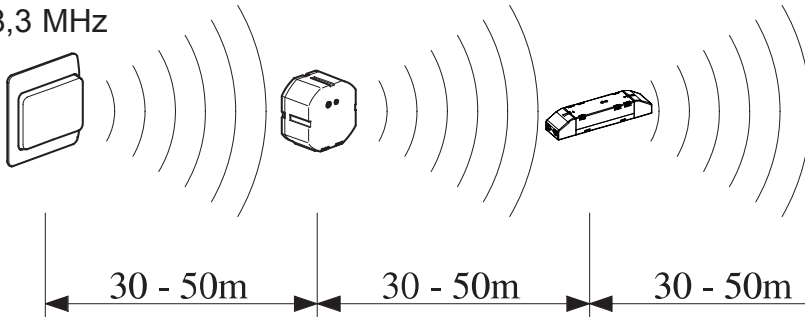

~ 60-90%	~ 80-95%	~ 20-60%	~ 0-10%	~ 70-90%

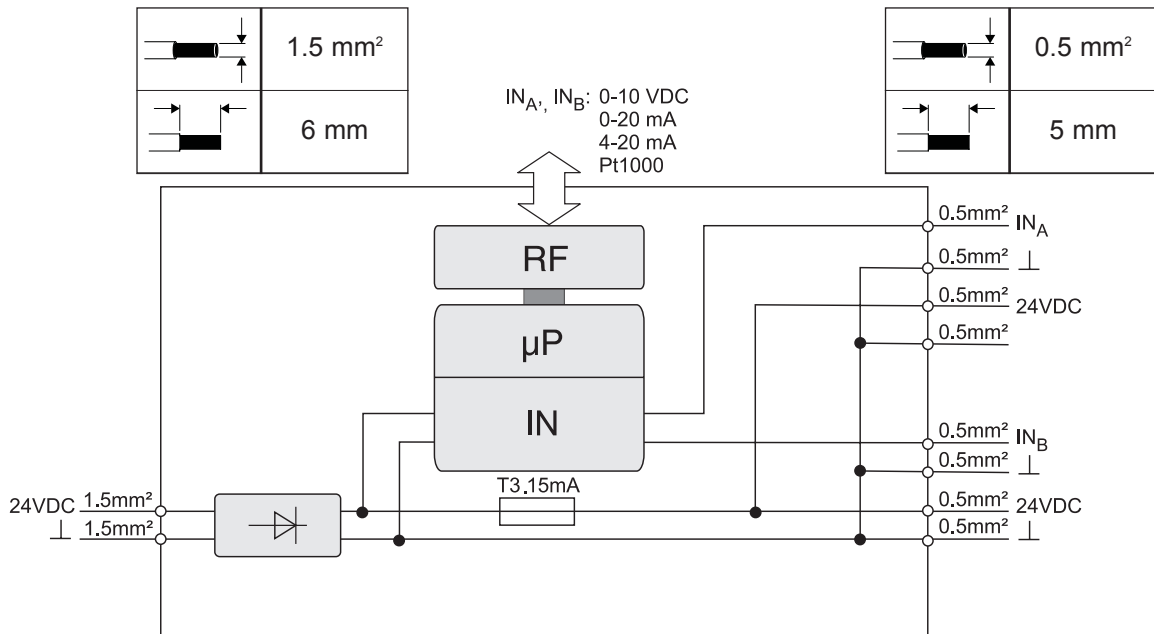

MOELLER 

Moeller Gebäudeautomation KG

Konformitätsbescheinigung
Certification of Conformity

Wir Moeller Gebäudeautomation KG

We (Name des Anbieters / supplier's name)
Eugenia 1
 A-3943 Schrems
 (Anschrift / address)

Wir bestätigen hiermit, daß das Produkt
 hereby certify that the product

Moeller - Analogaktor 0-10V DC
 Moeller Analogaktor 0-10V DC

Type: CAAE-01/01

type-key according actual catalog

(Bezeichnung, Type oder Modell, Los-, Chargen- oder Serien-Nr., möglichst Herkunft und Stückzahl /
 name, type or model, batch or serial number, possible sources and number of items)

auf das sich diese Bescheinigung bezieht, mit der/den folgenden
 Norm(en) oder normativen Dokument(en) übereinstimmt.

to which this certification relates is in conformity with the following standard(s)
 or other normative document(s).

EN301489-3 V1.4.1, EN50090-2-2/96 + A1/02, EN60669-2-1/04,
EN300220-3 V1.1.0, EN50371/02

(Titel und/oder Nr., sowie Ausgabedatum der Norm(en) oder der anderen normativen Dokumente /
 Title and/or number, and date of issue of the standard(s) or other normative document(s).)

Gemäß den Bestimmungen der Richtlinie(n)

Following the provisions of the Directive(s) falls zutreffend / if applicable

Niederspannungsrichtlinie 73 / 23 / EWG

Low Voltage Directive 73 / 23 / EWG

EMV-Richtlinie 89 / 336 / EWG

EMC Directive 89 / 336 / EWG

Radio- und Telekommunikationsendgeräte 99 / 05 / EWG

Radio Equipment and Telecommunications Terminal Equipment 99 / 05 / EWG

geprüft von / tested by TÜV Österreich, Notified Body 0408
A-1230 Wien, Deutschstrasse 10
CTI-Vienna
A-1210 Wien, Einznergasse 4

CE 0408

Eine rechtsverbindliche Konformitätserklärung gemäß EN 45014 liegt vor.
 The legally declaration of conformity according EN 45014 is available.

Schrems, 29.03.2005

(G. Idinger)

(Ing. F. Schröder)

(Ort, Datum der Ausstellung / place, date of issue)

(Name und Unterschrift / name and signature)



PDF der Konformitätserklärung fehlt

L1 N PE

CSEZ-01/14
CSEZ-01/15

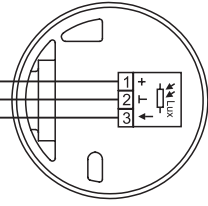

CSEZ-01/16

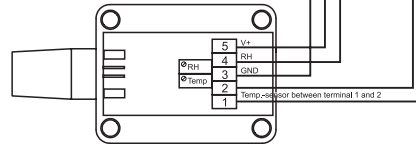
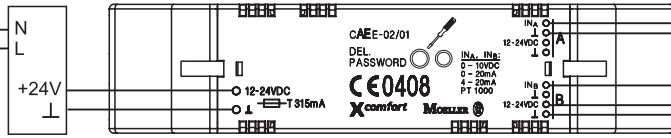
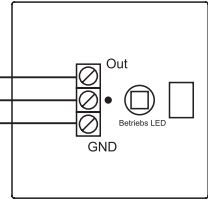

CSEZ-01/17

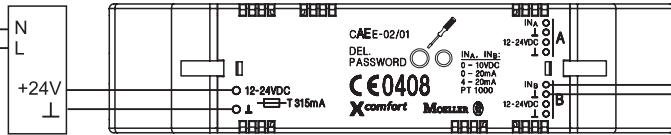

CSEZ-01/01
CSEZ-01/05

